

Instruction Manual

SGC – 650

Heading transmission device: GPS COMPASS



Rev. M00-0511-00



[Quick Start Guide]

1. Select an Installation site (Ref→ 4.1 Consideration in installation)

It should be installed above another antenna & structures referring to the followings.

What we recommend is to install as high as possible, without hiding sky.

- It should be installed away from the structure (Mast, etc.) which might interfere with reception of GPS signal.
- It should be installed outside Inmarsat & radar beam.
- It should be installed away from the antenna (VHF, etc.).
- It should be installed where there is no any shock or vibration generated by engine or wave.

2. Installation procedure (Ref→ 4.2)

- ① Make a platform to mount SGC-650 (Recommendable thickness: 5~10mm)
If required, it would be more convenient to use the platform to be provided as an option.
- ② Attach the Bird-repellent kit before installation.
- ③ Connect Power/Data cable (LTW18-15M-00) to the connector under SGC-650 and fasten the cable clamp. Make a loop to prevent cable fatigue.
- ④ The arrow heading to the bow should be parallel to the stern-the bow direction and face the bow.
Fasten the SGC-650 to the platform with hex, spring washers and flat washers.
- ⑤ Coat exposed parts of bolts and washers with Silicone Sealant.
And fix the cable to the pipe at suitable intervals with cable ties.

3. Power & Connecting to devices (Ref. → 4.3 Connecting to devices)

- Connect DC9V~DC33V to the power line(Red/Black) of SGC-650 'Power/Data Cable (LTW18-15M-00)' and get the data cable insulated after checking the equipment that needs heading data.
(Ref. → 7.2 CONNECTION DIAGRAM).
- If you want to convert **"RS422 TXD1"** to **"AD-10 TXD"**, you should connect **"AD-10 SEL"(7. Pink)** to **COMMON(14번 Grey).**
- The end parts of Wiring(s) that are not used in installation should be insulated.

4. Operation

- After Power-up (DC9V~DC33V), azimuth will be output within about 1minute and it will be renewed according to movement of the vessel.
- If you can't output Azimuth information, please refer to "5. Maintenance".
- Kinds of output sentences, output velocity, output gap was set the default value.
(Ref.→ 4.4 DATA I/O figuration) If you want figuration change, you can contact SAMYUNGENC.

---- **Table of contents** ----

[PRECUATIONS].....	4
1. SUMMARY.....	5
2. CONSTRUCTION.....	6
2.1 STANDARD CONFIGURATION.....	6
2.2 OPTION.....	6
2.3 SYSTEM FIGURATION.....	7
3. SPECIFICATION.....	8
4. INSTALLATION.....	9
4.1 CONSIDERATION.....	9
4.2 MOUNTING PROCEDURE.....	13
4.3 CONNECTION.....	16
4.4 DATA I/O SETTING.....	18
4.5 NMEA0183 OUTPUT SENTENCE.....	19
5. MAINTENANCE.....	20
6. PACKING LIST.....	21
6.1 SGC-650(STANDARD).....	21
6.2 SGC-650(OPTION).....	22
7. DRAWING.....	23
7.1 SGC-650 OUTLINE DRAWING.....	23
7.2 CONNECTION DIAGRAM.....	24
8. WARRANTY.....	25

[PRECUATIONS]

■ General

- Users should comply with the manual instruction. Wrong control or maintenance that does not correspond with the manual instruction can be beyond warranty.

■ To prevent operation error, fire, electric shock:

- Don't disassemble or modify the equipment.
- Power supply is compatible with the designated voltage rating of the equipment.
- Turn off the power on the switchboard before starting the installation.
- Consult with our C/S team or the branch about installation. An installation by an unqualified person can lead to a breakdown. A/S should be done at nominated areas.

■ To prevent the device being broken:

- All of dip switches inside the device should not be modified as it is controlled in the factory.
- Don't install the device at the spot where vibration or shock occurs.
- Don't put anything above the device.

■ Do not use the device in the place where it is not nominated to prevent an operation error or a breakdown.

■ Do not bend or twist cables inside the device. Otherwise, damage, fire, electrical shock on the cable can occur.

1. Summary

- With this device calculating the direction through two antennas using GPS Satellite signal, it can determine Heading. And this device outputting the data of Heading can be compatible with Radar, ECDIS, AIS and Autopilot usefully and effectively.
- In case there is some problem with the reception of the GPS signal under the bridge or owing to high skyscraper, gyro sensor & acceleration sensor equipped can replace it.

■ FEATURES

- Output a high level of accuracy and stability (0.3° RMS)
- 3axis gyro sensor & acceleration equipped with two
- Satisfy an international regulation IMO MSC. 116(73)
- brief hours for stability (within 2min)
- easy installation & maintenance
- Quick tracking velocity (45°/s)
- Output exact Heading, roll, pitch, ROT, COG, location, hours, velocity.
- A high level of data output (Max 115200 BPS)

■ This device complies with the following requirements:

- IMO MSC. 116 (73): Performance standard in response to Heading-transmission device
- ISO / FDIS 22090-3: Vessel & Marine-technology – Heading-transmission device
- IMO A. 694 (17): Basic requirements of GNSS for Vessel radio device & Electric sailing
- IEC 60945 (2002-08): Voyage & radio communication system -requirement- test method & result.
- IEC 61162 (2000): Voyage & radio communication system- digital interface

2. Construction

2.1 standard configuration

No	Description	Specification	Q'ty	Remark
1	Main	SGC-650	1	
2	Equipment for installation	SGC-650-A	1	
3	Bird-repellent kit	SGC-750A-BSA	1	Including adhesive
4	Instruction manual	SGC-650-ME	1	English

※ If you choose the Extension cable(LTW18-30M-00) as an option, 15m Power/data cable (LTW18-15M-00) will be replaced to it. Please refer to 6. PACKING LIST.

2.2 Option

No	Description	Specification	Q'ty	Remark
1	Extension Cable	LTW18-30M-00	1	L=30m
2	Antenna Mount	SGC-650A-M(S)	1	∅35 U-BOLT
		SGC-650A-M(L)	1	∅50 U-BOLT

2.3 System Figuration

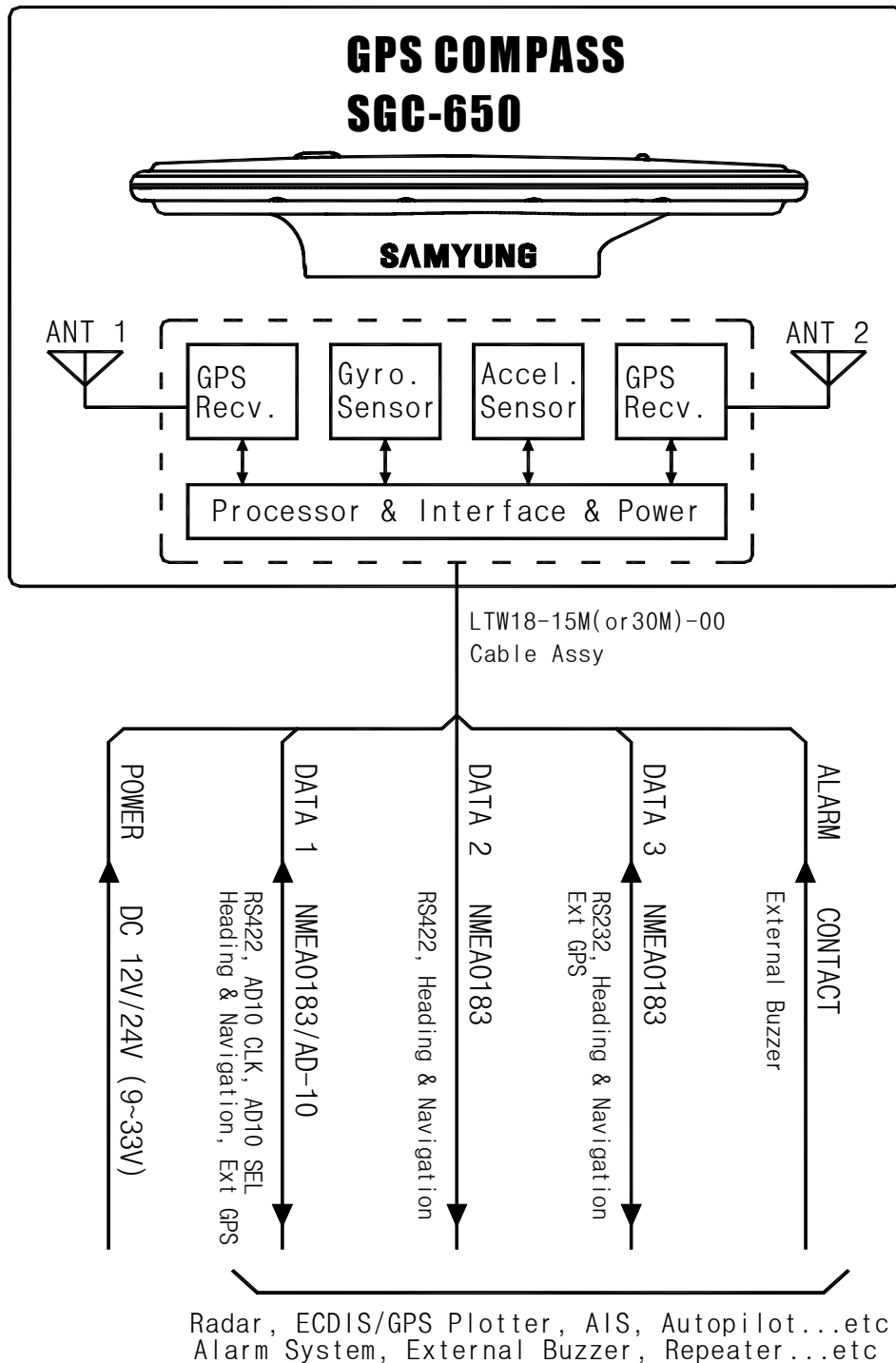

3. Specification

■ General

- Receiver Type 50-channel, L1 frequency
- Rx Frequency 1575.42 MHz(±1MHz)
- Rx Code C/A code, SBAS
- Position Accuracy GPS: 2.5 m CEP, SBAS: 2.0 m CEP
- Heading Accuracy 0.3° rms
- Follow-up 45°/s rate-of-turn
- Settling Time ≤ 2 minutes
- Roll/Pitch Output -60° ~ +60°

■ Interface

- Data protocol AD-10 / NMEA0183
- Serial ports RS-422: Input (1 PORT) /Output (2 PORT)
RS-232: Input (1 PORT) /Output (1 PORT)
- Baud rates 4800, 9600, 19200, 38400, 57600, 115200 bps
- Data bit 8 bit, parity: none, stop bit: 1 bit
- Output interval 1, 2, 5, 10, 20, 50Hz
- Sentence HDT, ROT, ATT, GBS, GLL, GSA, GSV, VTG, THS,
ALR, DTM, GGA, GNS, GST, RMC, ZDA

- Power supply DC 12V /24V (9~33V), 2.5W

■ Enviromental Condition & EMC

- Storage Temperature -25°C ~ +75°C
- Operating Temperature -25°C ~ +55°C
- Waterproofing IPX6
- Vibration IEC60945
- EMC IEC60945
- Compass Safe Distance 0.5M

- Dimension & Weight 680(W) x 230(D) x 135(H) mm / 2.5 Kg

4. Installation

4.1 Consideration

SGC-650 does use GPS satellite signal to output Azimuth. Accordingly, it must be installed where there is no problem with receiving GPS signal smoothly. Otherwise, decrease in accuracy of Azimuth, damage of the device and etc., might occur. In case you have difficulty in installing at the best place, do it as best as possible and see if there is no problem with operating vessel's features & devices, receiving a GPS signal before fixing it completely. And we recommend you to select the spot like the following as much as possible.

■ General considerations

▪ Install above other antennas & structures

Like in the figure below, SGC-650 mounts above other antennas and structures. This can keep the condition where there is not any reflection of the GPS signal and any interference with the GPS signal.

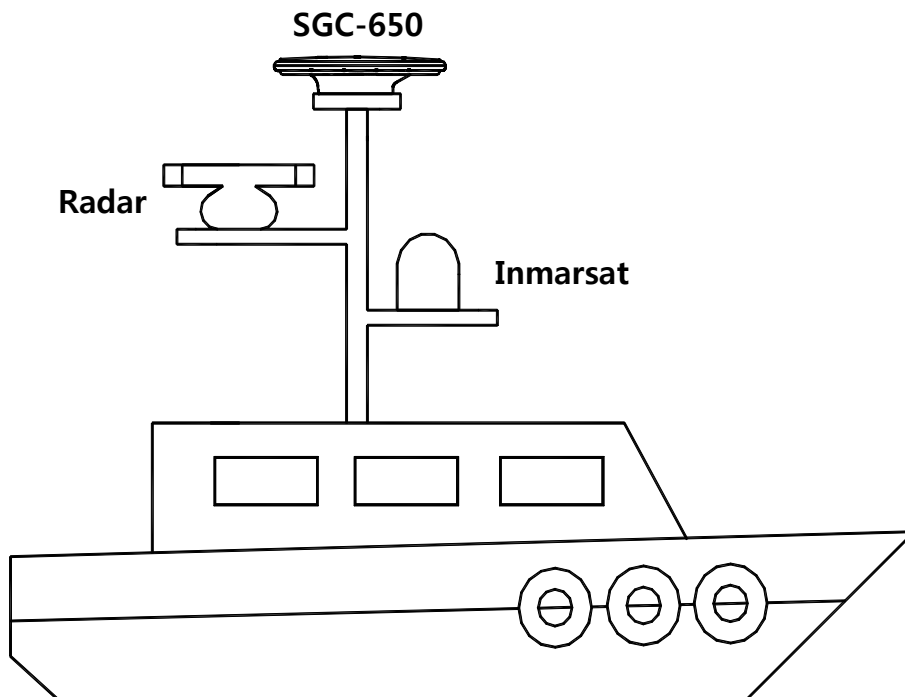

Fig-1 Mount it above others

▪ **If it can't be installed above other antennas & structures.**

If absolutely impossible to do otherwise, it can be installed below a radar mast.

However, it might prevent reception of the GPS signal or might decrease accuracy of azimuth or might interfere with connection. Accordingly, select a spot considering the followings to prevent any inconvenience.

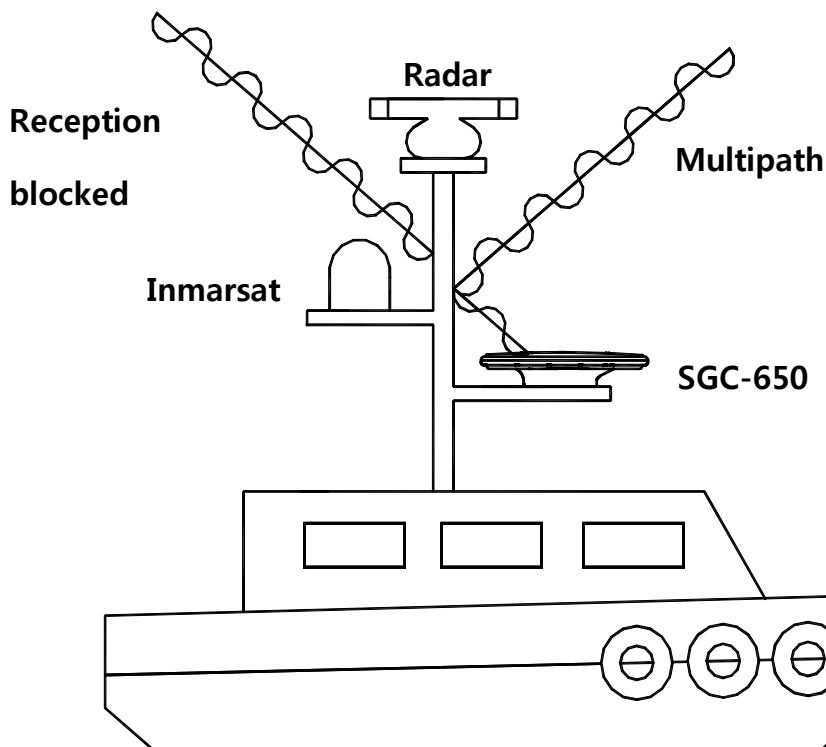

Fig-2 problems if it can't be installed above others.

■ **Selecting the installation site**

The installation site must satisfy the four conditions described in this section and surroundings and the structure of deck should be considered as well.

▪ **Condition 1, locate the SGC-650 away from masts that might prevent reception of the GPS signal.**

- Install it where the field of view against zenith is at least $\pm 85^\circ$. The installation site should be as high as possible, above masts, etc. which might prevent reception of GPS

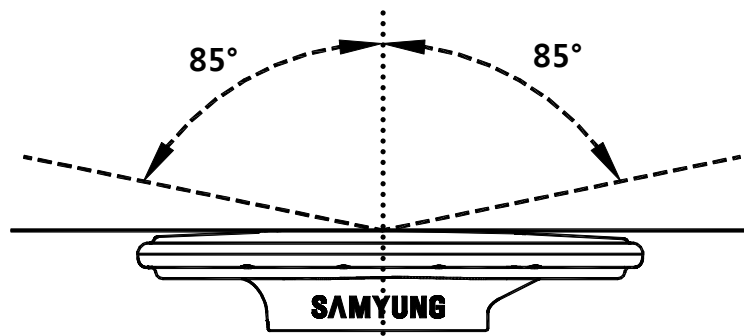

Fig-3 the field of view against zenith

- If above condition can't be satisfied, separate it from masts so that the horizontal angle to the interfering object is less than 10°. Refer to the table below to determine minimum separation distance.

Mast diameter	Min. Separation diameter
10 cm	1.5 m
30 cm	3 m

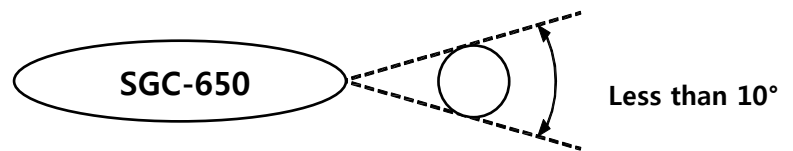

Fig-4 the horizontal angle to the interfering object

▪ **Condition 2, locate the SGC-650 out of Inmarsat & radar beam.**

- Separate the SGC-650 at least 3meters from an Inmarsat B antenna.
- Install SGC-650 more than 20° above the top of a radar antenna..
- Separate an Open-type of radar antenna from the SGC-650 more than three meters
- If it can't be separated at least three meters from an Inmarsat B antenna, install it at least 80cm above the top of the radar antenna.

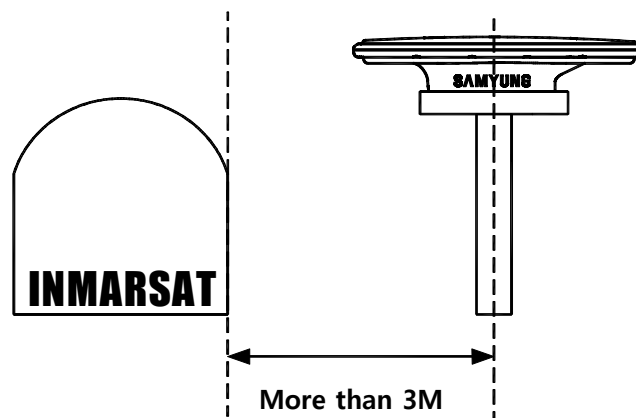

Fig-5 Distance from Inmarsat antenna

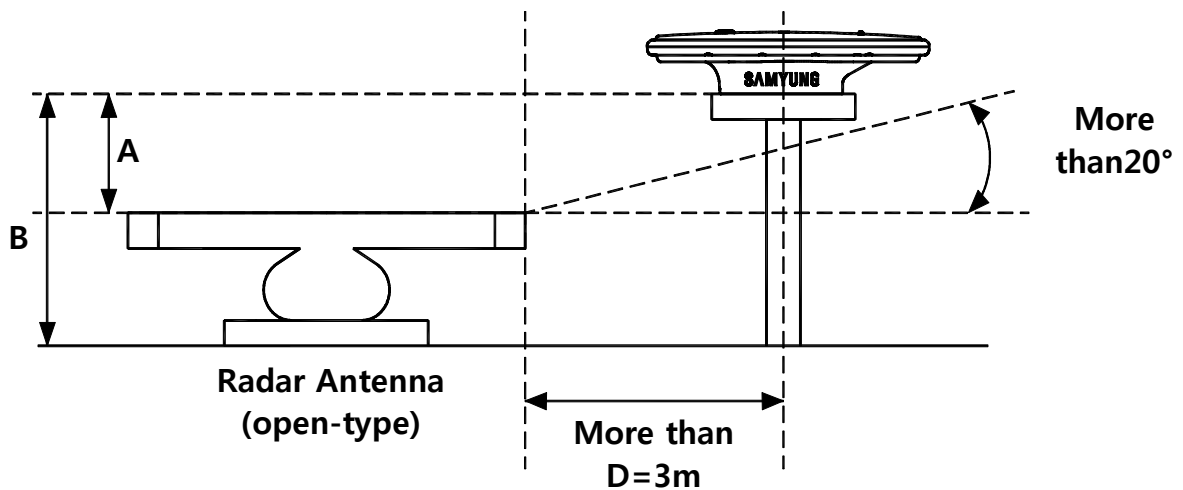

Fig-6 Distance form radar antenna

Location between radar antenna and SGC-650

- If, B is at least 1m and D is more than 3, the elevation angle from the radar should be more than 20°
- If D is less than 3m, A should be more than 0.8m.

▪ **Condition 3, locate the away from the communication Antennas(VHF, etc.).**

- Separate the SGC-650 as far as possible from communication antennas.

▪ **Condition 4, Select a stable site, no resonance location by engine or waves.**

- SGC-650 contains highly sensitive GPS and angular speed sensors. Therefore, install it where shock, vibration, etc. are normal.

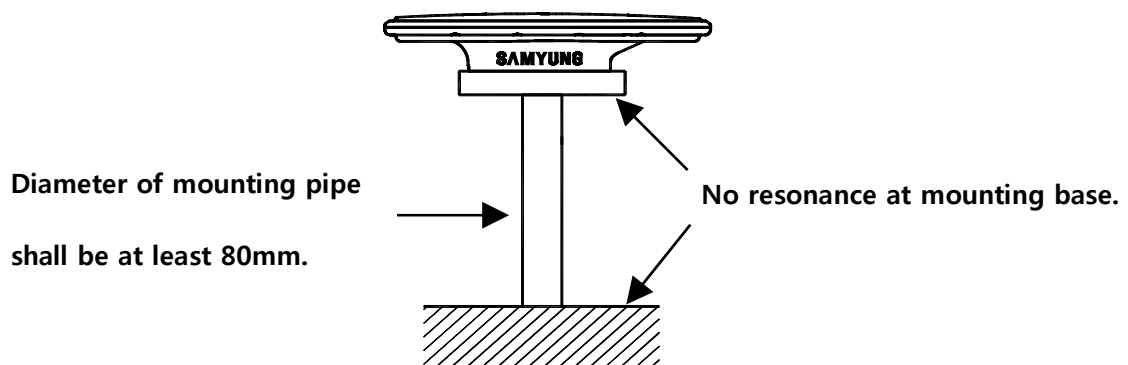

Fig-7 selecting a site without vibration

4.2 Mounting procedure

- 'Bird-repellent fixtures' can be attached to the above case to prevent birds from approaching on the cover. And you must attach it before mounting the device. (Refer to p16)

- As shown in the figure above, weld a Mount to fix the equipment.

The thickness of the Mount should be 5mm~10mm.

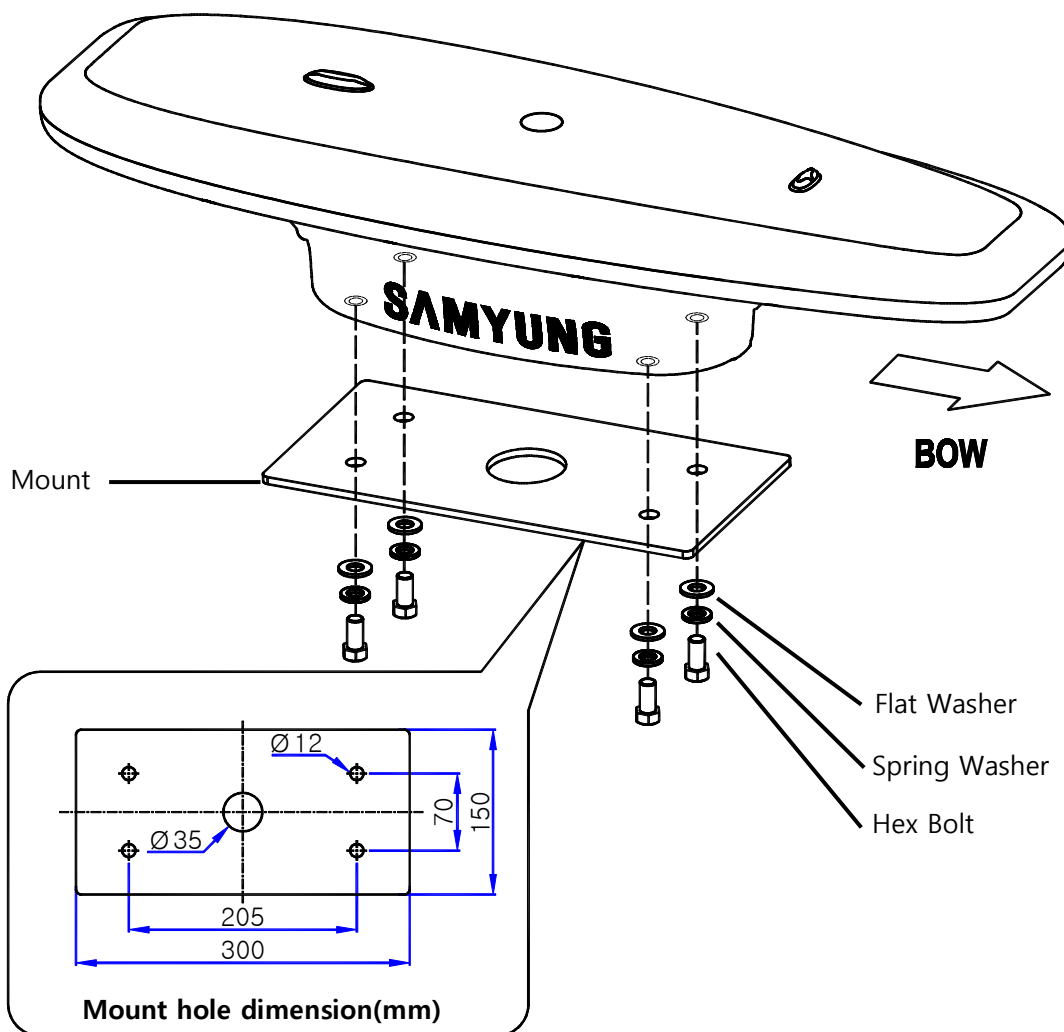

Fig-8 Mount

※If required, it is more convenient to use the optional Mount.

Please refer to the following.

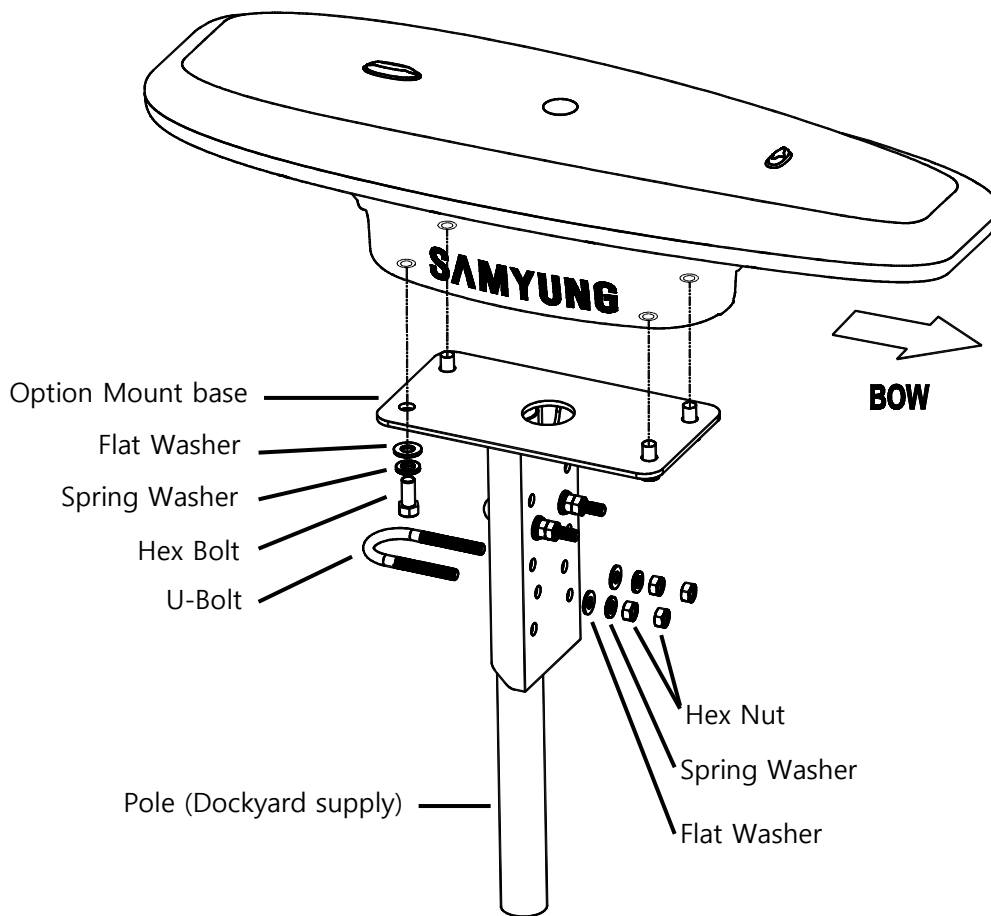

Fig-9 Optional Mount

■ Connect the cable (LTW18-15M-00) to the connector on bottom of SGC-650.

- Make a loop in the cable considering cable durability
- Tighten the cable holder to fix the cable.



Cable holder Loop

- Fix the SGC-650 to the Mount by using hex, spring washers and flat washers.
 - Use the tip for the direction adjustment on the upper case of SGC-650 to get the equipment paralleled to the stern-the bow direction.
 - The arrow on the bottom should be heading to the bow

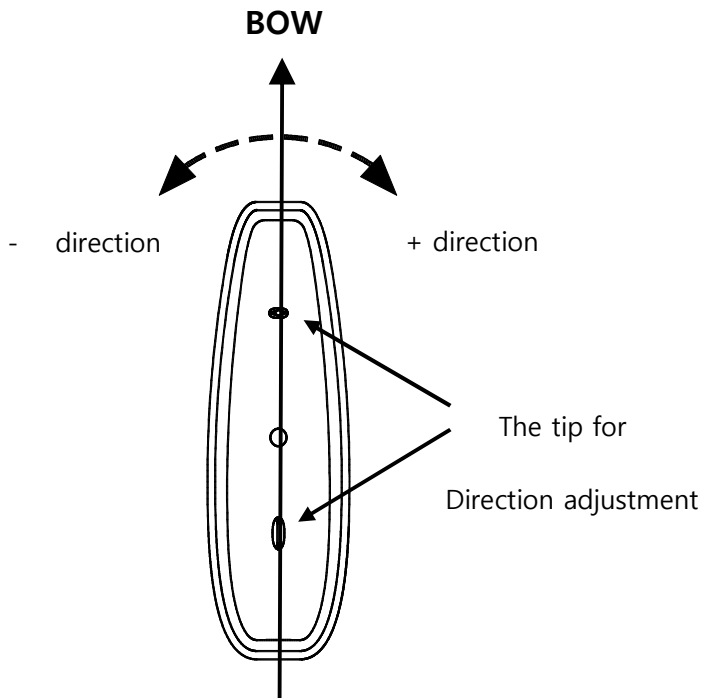

Fig-10 SGC-650 upper side

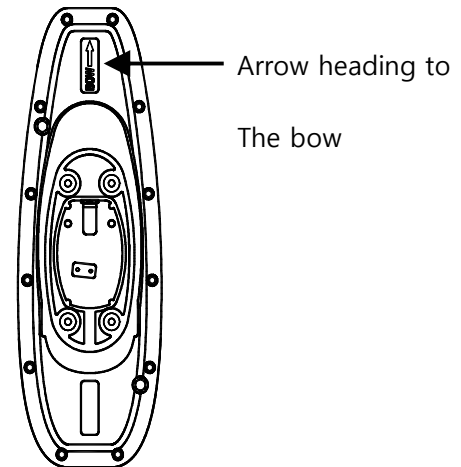

Fig-11 SGC-650 bottom

※ If it is impossible to put SGC-650 in the same direction of the stern-the bow due to any reason, you can offset and adjust that difference, with azimuth being offset as well.

If you want offset configuration, please contact our C/S team or an office.

- Coat exposed parts of bolts and washers with silicone sealant.

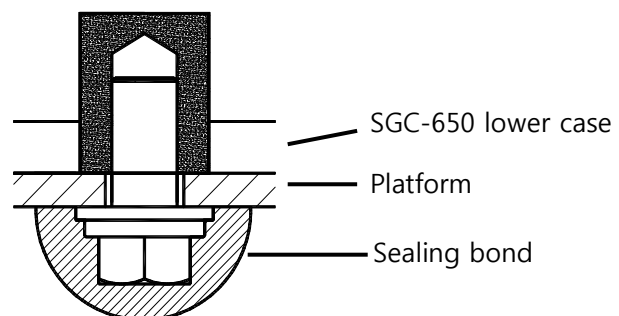

Fig-12 Coat exposed parts of bolts and washers

■ When you install cable(s), fix them at suitable intervals with cable ties and make sure of the followings.

- Don't pass through the spot overheated
- Away from equipment spinning.
- Don't bend the cable extremely and keep it twisted
- Don't keep the cable loosen.

■ Install a Bird-repellent kit

- Keep the spot a kit is attached to clean.
- Tear off the sticker on the bottom of a kit and attach like the following.
- Put adhesive on the surface to be attached. (Hardening hours: more than 24hours)

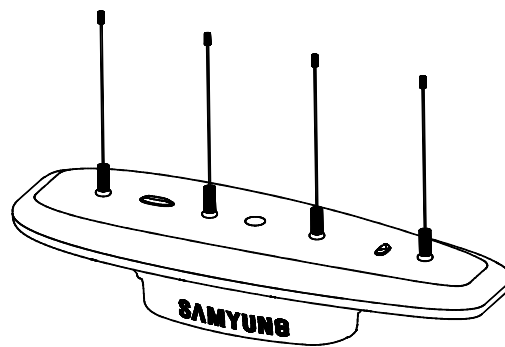

Fig-13 Bird-repellent kit

4.3 Connection

■ The following explains Power/data cable and connector pin for power supply and connection.

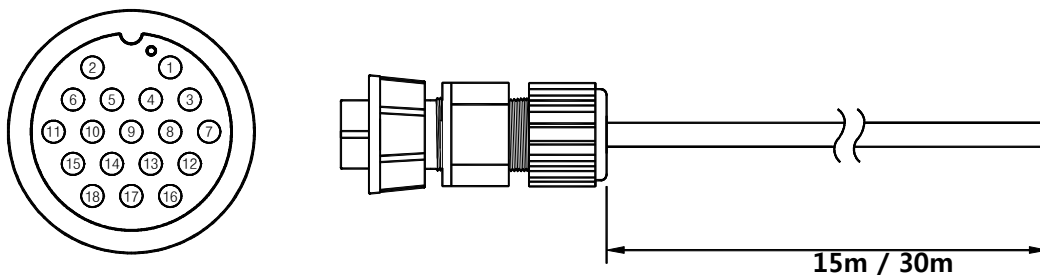

Fig-14 Power/Data Cable: LTW18-15M (or 30M)-00

Pin.	Wiring color	Function 1	Function 2	I/O	Name	Use
1	Black (Thick)	Power(-)		←	POWER	Power supply (DC9V~33V)
2	Red (Thick)	Power(+)				
3	Green/black stripe	RS422 TXD1-B	AD-10 TXD-B	→	DATA-1	Heading & Navigation information
4	Green	RS422 TXD1-A	AD-10 TXD-A			
5	Orange/black stripe		AD-10 CLK-B	→		AD-10 Clock
6	Orange		AD-10 CLK-A			
7	Pink		AD-10 SEL			Active-Low
8	Brown/black stripe	RS422 RXD1-B		←		External GPS
9	Brown	RS422 RXD1-A				
10	Yellow/black stripe	RS422 TXD2-B		→	DATA-2	Heading & Navigation information
11	Yellow	RS422 TXD2-A				
12	Blue/black stripe	RS232 RXD3		←	DATA-3	External GPS
13	Blue	RS232 TXD3		→		Heading & Navigation information
14	Grey	GND(Common)				
15		RESERVED				
16	White/red stripe	Alarm(-)		→	ALARM	External Buzzer, Normal Close
17	White	Alarm(+)				
18	Shield	Shield			SHIELD	

※ When you connect "AD-10 SEL"(7. Pink) with COMMON (14. Grey), "RS422 TXD1" is automatically revised "AD-10 TXD".

Though "RS422 TXD1" of is revised to "AD-10 TXD", it is possible to use "RS422 RXD1" separately or combine with "RS422 TXD2"

4.4 DATA I/O Setting

■ When we release SGC-650 out of the factory, it's set point is underlined as below.

-Actual set point underlined.

DATA1	<u>NMEA</u> (RS422)	Baud rate	4800, 9600, 19200, <u>38400</u> , 57600, 115200 bps	
		Sentence	<u>HDT</u> , THS, <u>ROT</u> , ATT	OFF, 1, 2, 5, 10, <u>20</u> , 50Hz
			<u>GGA</u> , GLL, GNS, <u>RMC</u> , VTG, ZDA, DTM, GBS, GSA, GST, GSV, <u>ALR</u>	OFF, <u>1Hz</u>
AD-10	25ms, 200ms			
DATA2	<u>NMEA</u> (RS422)	Baud rate	<u>4800</u> , 9600, 19200, 38400, 57600, 115200 bps	
		Sentence	<u>HDT</u> , THS, <u>ROT</u> , ATT	OFF, 1, 2, <u>5</u> , 10, 20, 50Hz
			GGA, GLL, GNS, <u>RMC</u> , VTG, ZDA, DTM, GBS, GSA, GST, GSV, <u>ALR</u>	OFF, <u>1Hz</u>
DATA3	<u>NMEA</u> (RS232)	Baud rate	4800, 9600, 19200, <u>38400</u> , 57600, 115200 bps	
		Sentence	<u>HDT</u> , THS, <u>ROT</u> , ATT	OFF, 1, 2, 5, 10, <u>20</u> , 50Hz
			<u>GGA</u> , GLL, GNS, <u>RMC</u> , VTG, ZDA, DTM, GBS, GSA, GST, GSV, <u>ALR</u>	OFF, <u>1Hz</u>

※ If you want to get set points revised, contact our C/S team or agents.

4.5 NMEA0183 Output Sentence

- ALR - Set Alarm State
- ATT - Attitude information
- DTM - Datum reference
- GBS - GNSS satellite fault detection
- GGA - Global positioning system (GPS) fix data
- GLL - Geographic position – latitude/longitude
- GNS - GNSS fix data
- GSA - GNSS DOP and active satellites
- GST - GNSS pseudo range noise statistics
- GSV - GNSS satellites in view
- HDT - Heading true
- RMC - Recommended minimum specific GNSS data
- ROT - Rate of turn
- THS - True heading and status
- VTG - Course over ground and ground speed
- ZDA - Time and date

5. Maintenance

- To keep the high quality, regular maintenance is important.

Please refer to the following information of how to maintain.

■ Prevention

- As there is no part structurally moving, minimum prevention is required

Item	Checking point	Treatment
Cable	-Check abrasion and damage by visual -Check whether connector is fastened	-Replace the cable -Get it fastened
Cover	-Check the contamination	-Remove dust by a tower. Do not use detergent containing chemical component in cleaning.





■ Failure symptom & Check



Symptom	How to check
Can't output Azimuth.	Check "Power supply". DC 12V /24V (9~33V)
	Make sure that there is no problem with all the wiring and connector(s) fastened.
	Check whether there is any defective or damage on the cable.
	Check transmission velocity of output data.
Inexact Azimuth output	Check SGC-650 is installed in parallel with the center line of vessel.
	Check whether arrow on the lower case is facing the bow.
	Check interference with other antennas and structures.
Can output the location & GPS-related article, but can't output azimuth regularly.	Check interference with other antennas or communication devices near an installation site.
	Check the vibration generated in an installation site.
GPS reception error	Check interference with other antennas and structures.
	Check there is ice on the upper case.

6. PACKING LIST

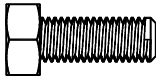
6.1 SGC-650(Standard)

Main frame SGC-650						
NO.	ITEM	EXTERNAL FEATURE	DESCRIPTIONS	Q'TY	CHK	REMARK
1	UNIT		SGC-650		1	
			CODE NO.			





Equipment for installation SGC-650-A						
NO.	ITEM	EXTERNAL FEATURE	DESCRIPTIONS	Q'TY	CHK	REMARK
1	WASHER		ST FLAT WASHER M10		4	
			CODE NO.	901-0101-01		
2	WASHER		ST SPRING WASHER M10		4	
			CODE NO.	901-0001-01		
3	BOLT		ST HEX BOLT M10X25		4	
			CODE NO.	900-0800-01		
4	CABLE ASSY		LTW18-15M-00		1	15m Power/data
			CODE NO.			
5	CABLE TIE		DACT200-4.8		3	
			CODE NO.	597-0050-3D		





Bird-repellent Kit [SGC-750A-BSA]						
NO.	ITEM	EXTERNAL FEATURE	DESCRIPTIONS	Q'TY	CHK	REMARK
1	ASSY		SGC-750A BIRD repellent		4	
			CODE NO.	E03-9001-02		
2	Bond		adhesive		1	
			CODE NO.	E03-9090-03		

Manual instruction SGC-650-MK						
NO.	ITEM	EXTERNAL FEATURE	DESCRIPTIONS	Q'TY	CHK	REMARK
1	MANUAL		SGC-650-ME		1	English
			CODE NO.	M00-0511-00		

6.2 SGC-650(Optional)

Data cable						
NO.	ITEM	EXTERNAL FEATURE	DESCRIPTIONS	Q'TY	CHK	REMARK
1	CABLE ASSY		LTW18-30M-00	1		30m Power/data
			CODE NO.			

Antenna [SGC-650A-M(S)]						
NO.	ITEM	EXTERNAL FEATURE	DESCRIPTIONS	Q'TY	CHK	REMARK
1	BRACKET		SGC-650A-M	1		
			CODE NO.			
2	U BOLT		Ø35 M8 U-BOLT	2		Ø35
			CODE NO.			
3	WASHER		ST FLAT WASHER M8	4		
			CODE NO.			
4	WASHER		ST SPRING WASHER M8	4		
			CODE NO.			
5	NUT		ST NUT M8	8		
			CODE NO.			

Antenna platform [SGC-650A-M(L)]						
NO.	ITEM	EXTERNAL FEATURE	DESCRIPTIONS	Q'TY	CHK	REMARK
1	BRACKET		SGC-650A-M	1		
			CODE NO.			
2	U BOLT		Ø50 M8 U-BOLT	2		Ø50
			CODE NO.			
3	WASHER		ST FLAT WASHER M8	4		
			CODE NO.			
4	WASHER		ST SPRING WASHER M8	4		
			CODE NO.			
5	NUT		ST NUT M8	8		
			CODE NO.			

7.2 CONNECTION DIAGRAM

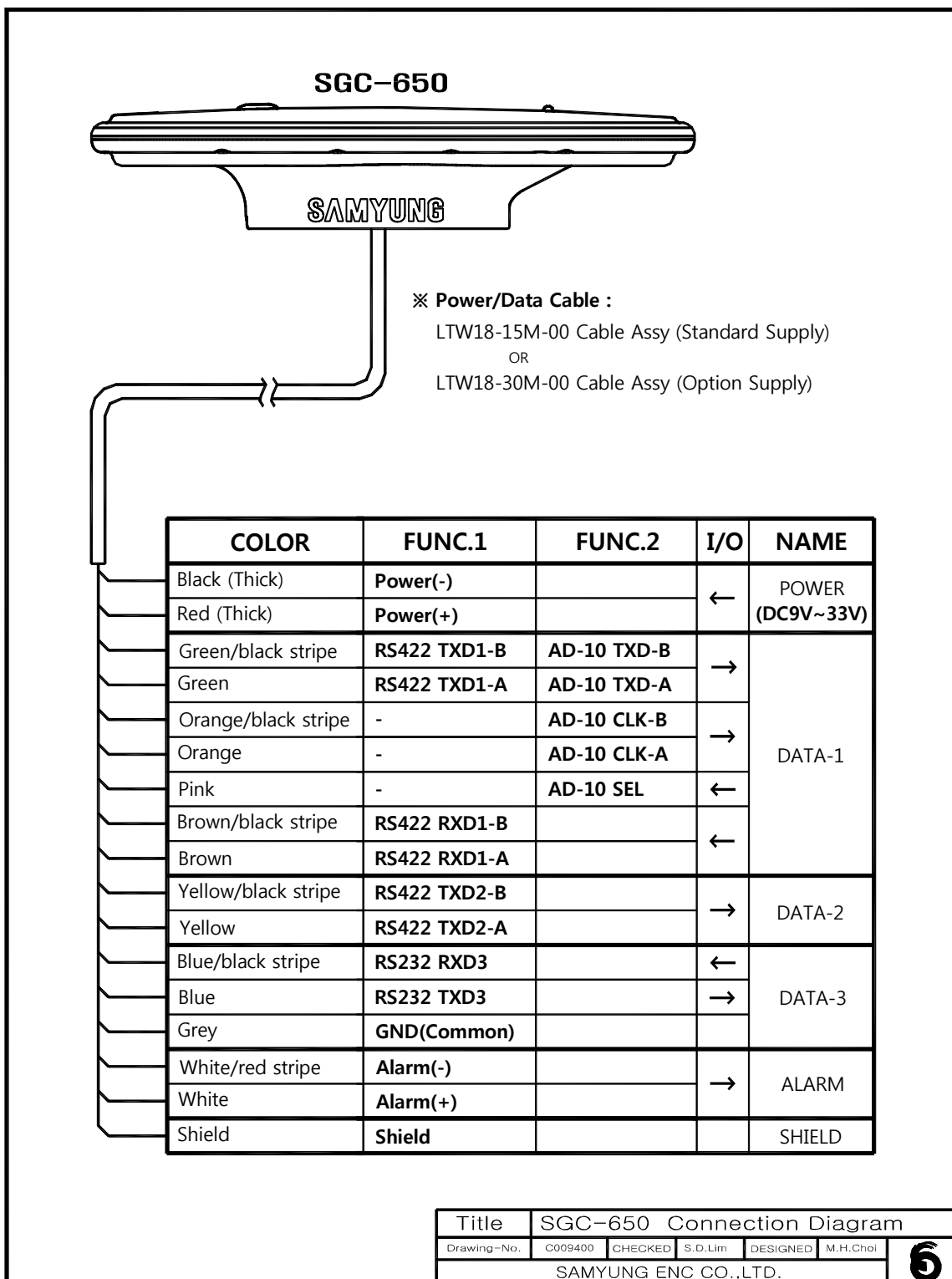

※ In case you change "RS422 TXD1" function to "AD-10 TXD" function (FUNC.2),

connect "AD-10 SEL (Pink) of [DATA-1] to GND (Grey).

※ Wiring(s) that are not used in installation should be insulated to prevent short.

8. Warranty

Deeply grateful for purchasing "SGC-650". This Manual instruction describes ways of using it and what to consider, etc. Please pay attention not to lose and keep it in a safe area. In case you sell or lend "SGC-650", provide it together to a new user. We hereby certify that we guarantee free of maintenance for 1year after the purchase date. However, we can't provide free of maintenance for defective(s) generated by improper use & modification on your purpose.

Head office (A/S)	
Address	69 Sangni-Ro, Youngdo-Gu, Busan, Korea, 49089
Firm & Dep.	C/S Dep. In SAMYUNGENC
TEL	A R S : 1577-0198
	F A X : 051-416-5515
<p>If you let me know Part name, S/N, operation status, etc., by call or Fax, we will help you solve your problems.</p>	

Location of Office or Branch (A/S)	
Contact	
Tel	TEL :
	Mobile Phone :
Make sure to Have the contact point in purchasing	

[http : //www.samyungenc.com](http://www.samyungenc.com)

[Head office] 69 Sangni-Ro, Youngdo-Gu, Busan, 49089

Tel : (051)601-5555, 6666(Representative)

Fax : (051)413-4446 , 412-6616

[C/S] 69 Sangni-Ro, Youngdo-Gu, Busan, 49089

ARS : 1577-0198

Fax : (051)416-5515

[Seoul office] Tel : (02) 569-6242

[Taeon office] Tel : (041)673-5572

[Mokpo office] Tel : (061)243-2568

[Jeju office] Tel : (064)757-1889